

EVIDENCE STORAGE

Storage. For Good.™



WOMEN'S
RESTROOM



SUPPLIES

REPORT WRITING ROOM

CALL
TRAINING
ROOM

EVIDENCE DEPOSIT

PASS-THRU LOCKERS

EVIDENCE RETRIEVAL

PASS-BACK LOCKERS

REFRIGERATED

TO GARAGE

MAIL/COPY
ROOM

EVIDENCE
DEPOSIT

NON-PASS-THRU
LOCKERS

REFRIGERATED

DRYING
CABINET

EVIDENCE & PROPERTY ROOM

CURRENCY

TECTIVE

EVIDENCE STORAGE
HIGH-DENSITY MOBILE STORAGE SYSTEM

TECTIVE

GUNS

NARCOTICS

TO PUBLIC
ENTRANCE

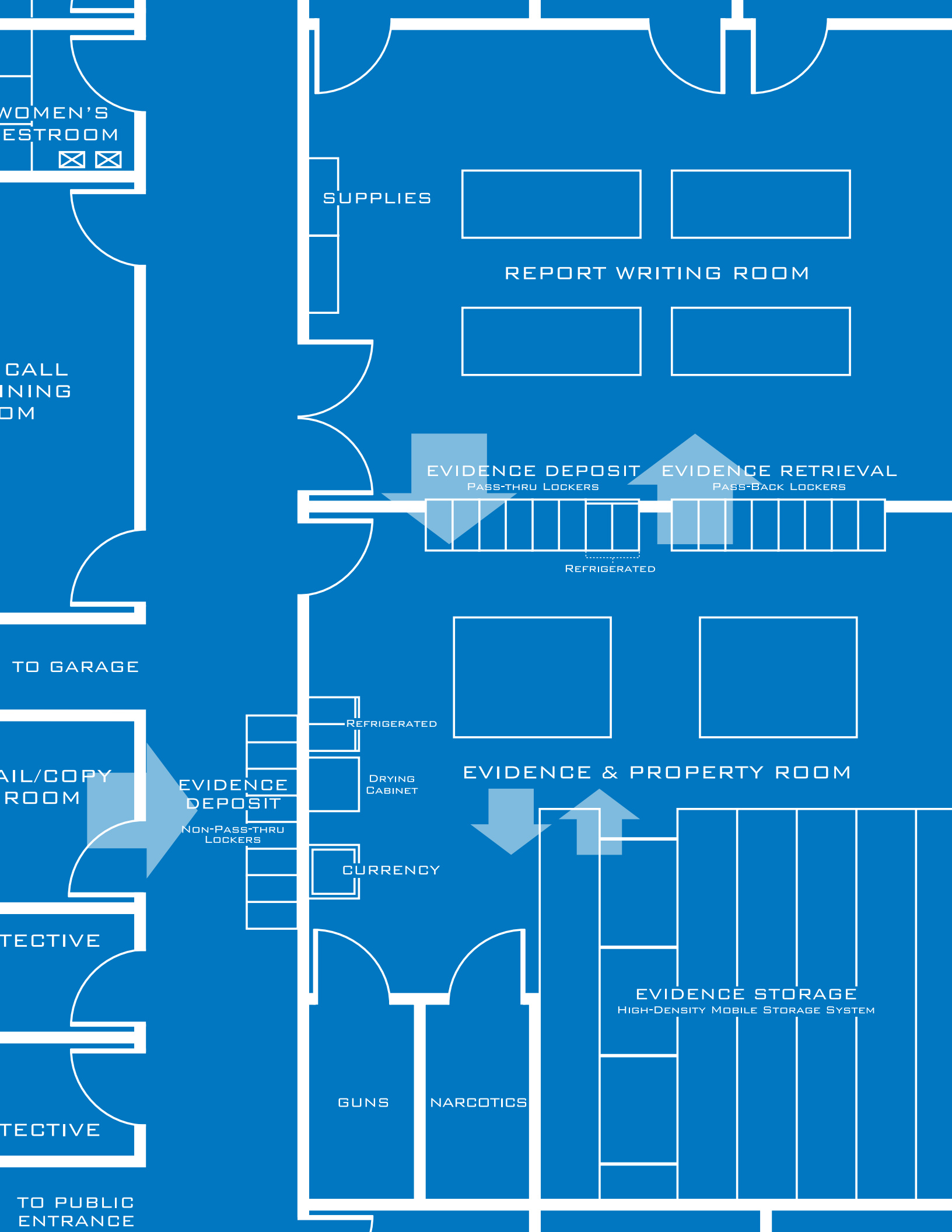

SECURITY. THE STRONGEST LINK.

Evidence – a crucial component needed for taking a case from collar to conviction. The chain of custody must be preserved and the integrity of evidence protected.

Spacesaver® the trusted name in evidence storage systems has designed secure storage solutions to meet the needs of any department's evidence handling processes. Whether you require lockers for your temporary storage of evidence or need the long-term storage solution of our high-density mobile systems. Spacesaver evidence storage solutions can store the most unique objects we know you have, from now to forever.

www.storageforgood.com





Spacesaver's pass-through evidence lockers, which are designed to secure the chain of custody during the critical short-term evidence storage period, were built into the wall that separates the evidence drop-off area from the property and evidence room.

Evidence can arrive for processing any time of the day or night. Until it's received by a property room employee, you need a temporary storage solution that can guarantee the security and integrity of evidence. Evidence lockers from Spacesaver provide a secure chain of custody with two distinctive storage processes, both of which do not require keys for deposit of evidence.

INTEGRITY. STANDARD.

PASS-THRU LOCKERS

The pass-thru locker is built into the wall, allowing evidence to be deposited from one side and retrieved from another. The full-size rear door allows the evidence technician to efficiently remove items and reset the locker openings for use.

To further enhance security, we offer an optional front-lock-out system. This feature will automatically lock the front doors when the rear door is opened preventing unauthorized access to the evidence and property room through a locker opening.

NON-PASS-THRU LOCKERS

Unlike the pass-thru locker, evidence is both deposited and retrieved from the same self-closing doors. Items can only be removed by authorized personnel. Our lockers easily mount against a wall and can be converted into a pass-thru configuration at a later date.



The rear door on the pass-thru evidence locker allows for easy removal and reset functions and the convenience of managing a single lock per unit.



Unauthorized access denied.

For ultimate security, the multipoint dead bolt locking system, double-walled, welded doors and anti-pry tabs provide assurance that evidence will not be compromised.

Keyless deposit.

Depositing evidence is simple and efficient with our unique keyless, push-button lock system.



Functional style.

Our nickel-plated recessed handle prevents items and clothing from becoming snagged.



Smooth operation.

The stainless steel, continuous door hinges are self-closing and rest flush with the locker. The tamper-proof pins provide reliable, secure use for years to come.

Ergonomics in mind.

A built-in toe kick assists in alleviating strain when depositing heavy evidence into lockers.





Space that works smarter.

Our standard 82" height offers maximum storage capacity. Multiple door sizes and configurations are available for ultimate customization to your required needs.



Attention to detail.

As a finishing touch, trim kits and concealed fasteners throughout offer a secure, pleasing appearance.

Built to last.

Evidence lockers feature heavy-gauge, welded construction for a lifetime of durability. The high-quality powder coat finish resists rust and scratches.

Ironclad promise.

Spacesaver stands behind every evidence locker with a lifetime warranty on the frame and a 5-year warranty on moving parts.

ULTIMATE



ACCOUNTABILITY.

INCREASED ACCOUNTABILITY WITH CONTROLOC® TECHNOLOGY BY SPACESAVER®

The ControLoc line of secured evidence lockers allows departments to control and review access to each individual locker location in real time. With full network capability, ControLoc® Technology from Spacesaver®, will allow authorized personnel to track and document which officers and evidence technicians access the system, which evidence lockers they entered, and the date and time of every transaction. This can be done on-site or from another building. Access to the individual evidence locker areas is gained through an access card and a numeric control pad providing the highest level of security.

Complete control.

The ControLoc Technology boasts features that offer unparalleled preservation of the chain of custody, including:

- Computerized tracking and monitoring of user and locker door activity.
- On-demand activity report generation.
- Automatic door locking when not being accessed.
- Multiple levels of security.
- Remote monitoring of multiple locations from a central location.
- Windows-based software and on-site setup and training.
- Five different modes of operation.



PRESERVING BIOLOGICALS.



REFRIGERATED LOCKERS

Your local appliance distributor doesn't understand the importance of the chain of custody of evidence. So why would you store your critical biological evidence in a standard residential refrigerator with a chain and padlock? Our refrigerated evidence lockers offer the same performance, reliability and security that our standard evidence lockers come with, both with pass-thru and non-pass-thru functionality.

Solid and secure.

- Magnetic seals on front and rear doors.
- Stainless steel double-wall interior.
- Push-button, keyless lock system.
- Variety of lockable compartments.

Keeping a constant cool.

- Refrigerated evidence lockers will maintain a constant 38 to 42 degrees.
- Air circulating fan eliminates hot or cold spots.
- Alarm system to notify authorized personnel of any significant temperature variances.

The full-size refrigerated evidence locker offers 4–24 compartments in various sizes.

The small refrigerator unit is designed to stand alone or fit into any lower 'D' size opening of our evidence lockers. Can be installed on-site into existing evidence lockers as well. Comes standard with four lockable compartments.



EVIDENCE DRYING CABINET SYSTEM

To completely meet all of your temporary evidence storage needs, we offer the Drying Cabinet to safely and securely air-dry blood and biological evidence.

- Connects to existing or new exhaust ducts.
- Secured by a combination lock.
- Louvered door vents with replaceable filter for improved air circulation.
- Magnetic seal prevents odors.

Easy to clean.

- Three racks and one hanger rod that can be removed for cleaning.
- Stainless steel interior components and parts.
- Radius interior corners and a drainage pipe with shut-off valve.



Biological evidence like sexual assault kits can be stored on an Eclipse® Powered System in half the space of stationary shelving.



Well known as the leader in High-Density Mobile Storage (HDMS) systems, Spacesaver has the expertise to match specific storage needs ranging from high-profile evidence to general property. Our product solutions provide well-organized, space-efficient storage for today, next year or indefinitely.

OPTIMIZED EFFICIENCY.



Utilizing available space long-term.

Our mobile systems offer secondary levels of security segregated from general evidence whether it's located in a separate room or with Spacesaver's patented locking mechanisms. The storage carriages allow for a variety of storage applications:

- Hanging folders for documentation and general evidence
- Shelving for boxed evidence
- Hand guns and long guns

These systems can be equipped with touch-pad access for sensitive areas and may be tied into office fire alarm and security systems.

When you add it all together, there really is no comparison. Spacesaver is the industry leader in mobile storage solutions.



To maximize the use of limited space, an Eclipse® Powered System uses customized shelving to accommodate pistol and rifle boxes. Narcotics are stored beyond the secured access door.



Designed specifically for warehouse environments, ActivRAC® mobilized storage systems enable for more bulk property and evidence in less space, better organization and less time searching for items. The result...better efficiency and less cost.

INSTANT ORGANIZATION.

What you call aisles, we call wasted space.

Static shelving or racking wastes as much as 64% of available property and evidence storage space. Mobilized storage systems eliminate this costly waste to deliver an immediate boost to space efficiency and productivity. Our system, ActivRAC, eliminates the need for multiple dedicated aisles of racks, saving space and/or increasing your storage capacity.

Spacesaver's ActivRAC line of mobilized warehouse shelving systems feature:

- Easily and efficiently store large, bulky evidence items that otherwise hog your floor space.
- Mount your existing racking or shelving on top of ActivRAC mobilized bases.
- The specially engineered track sits right on top of the existing floor.
- Convenient control operation (hand-cranked or motorized push button systems)
- Reliable, safe and easy to use.



SELECTION WORKSHEET

STANDARD EVIDENCE LOCKER CONFIGURATIONS

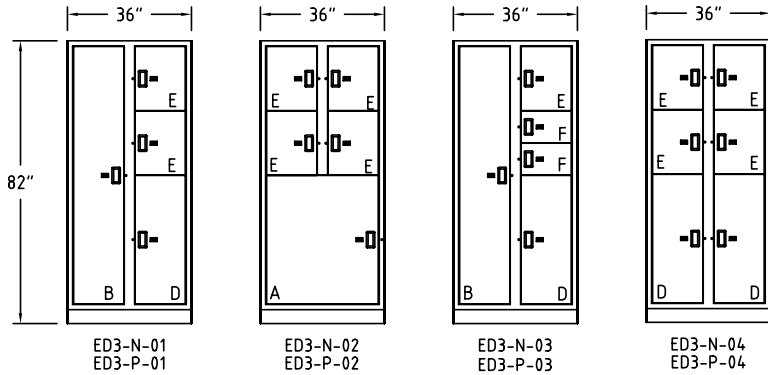

- ALL CONFIGURATIONS AVAILABLE IN NON PASS-THRU (N) AND PASS-THRU (P).
- Small refrigerator can be added to configurations 01, 03, 04, 05 and 18.
- Mail slots can be added to any "E" size doors.
- Available in 32 colors.
- Custom configurations available upon request.

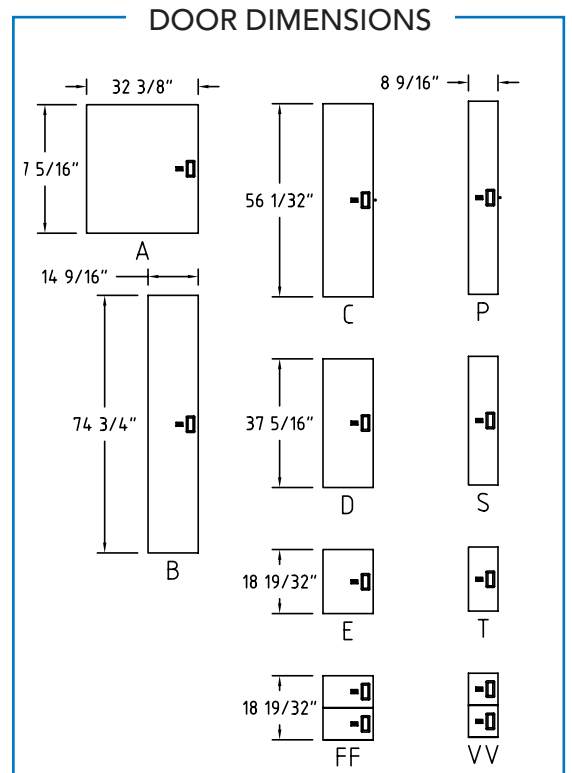
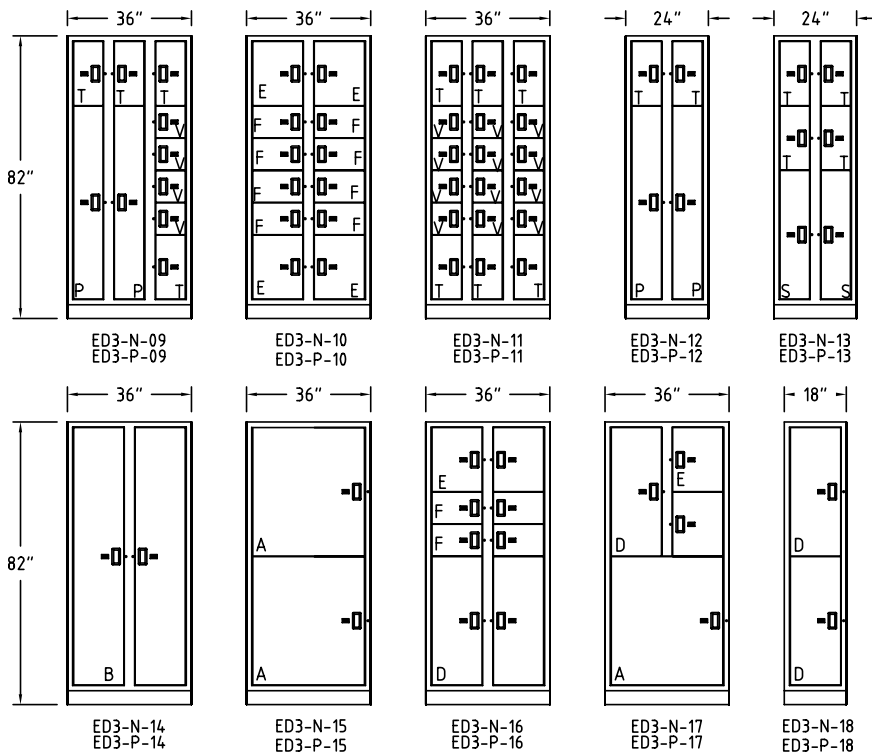
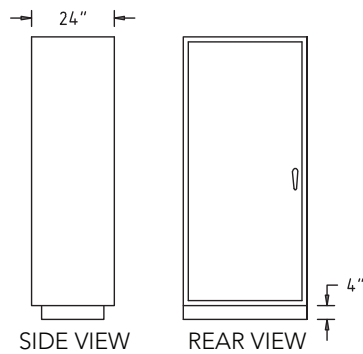
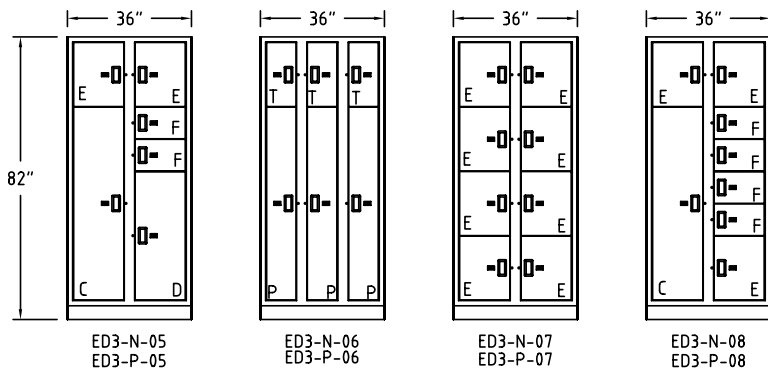

OTHER EVIDENCE LOCKER CONFIGURATIONS:

*Consult factory on price and lead-time for non-standard configurations.

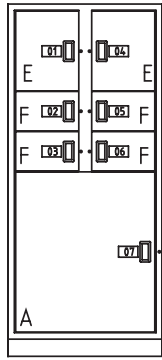

ED3P19

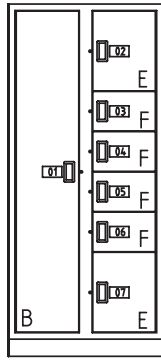

ED3P21

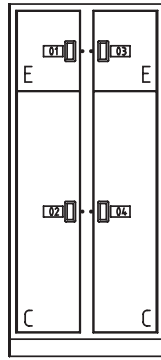

ED3N22
ED3P22

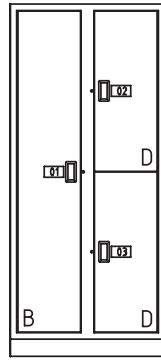

ED3P23

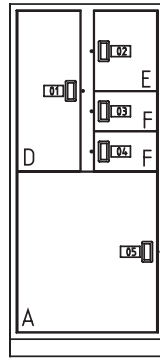

ED3P25

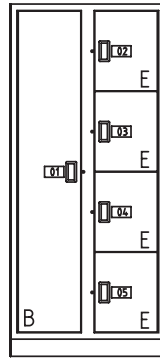

ED3P26

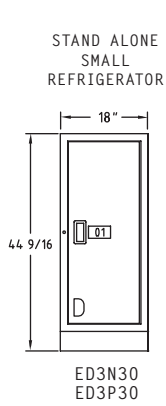

ED3N30
ED3P30

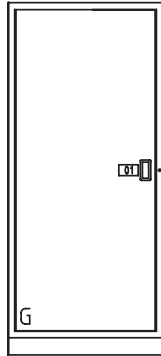

ED3P31

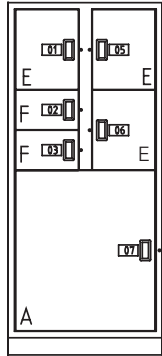

ED3P32

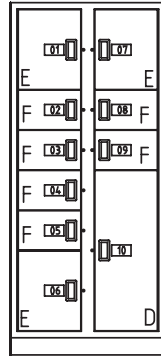

ED3P33

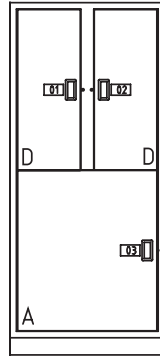

ED3P34

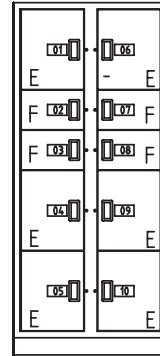

ED3N35

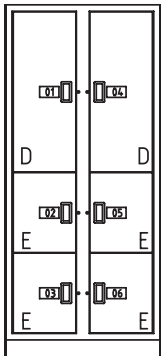

ED3N36

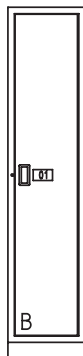

ED3P37

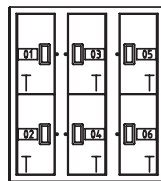

ED3N38NB

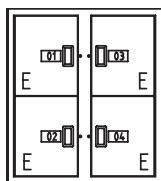

ED3N39NB

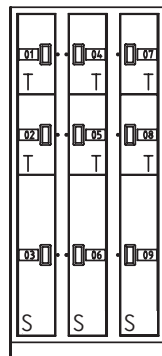

ED3P40

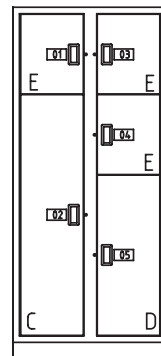

ED3P41

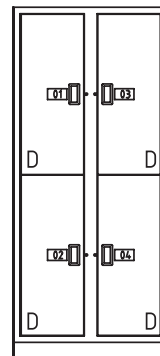

ED3P42

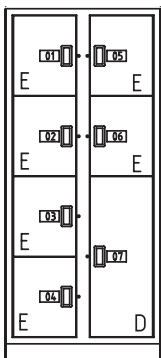

ED3P43

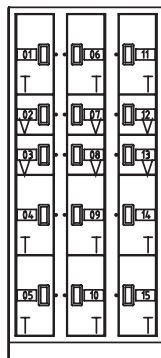

ED3P44

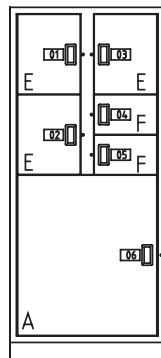

ED3P45

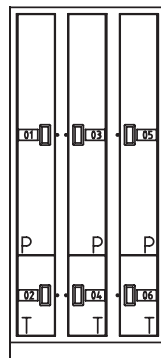

ED3N46

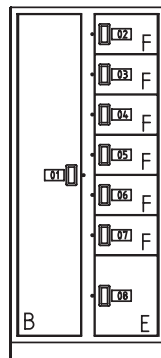

ED3P47

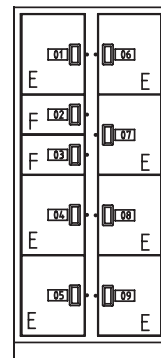

ED3P48

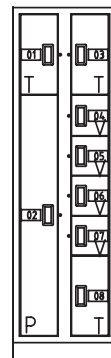

ED3P49

OTHER EVIDENCE LOCKER CONFIGURATIONS:

*Consult factory on price and lead-time for non-standard configurations.

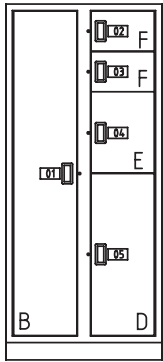

ED3P50

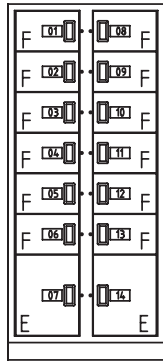

ED3P51

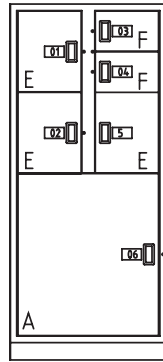

ED3P52

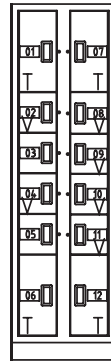

ED3P53

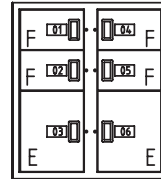

ED3N54NB

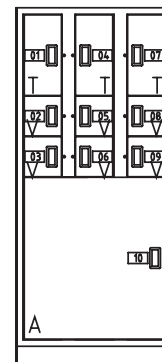

ED3P55



ED3P56

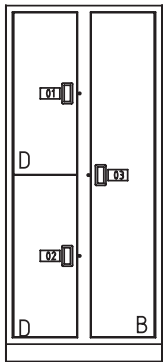

ED3P57

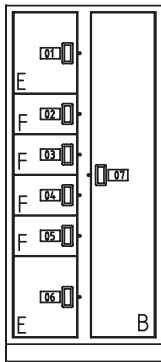

ED3P58

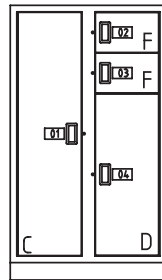

ED3P59

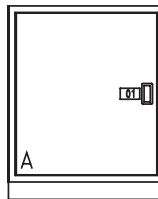

ED3N60

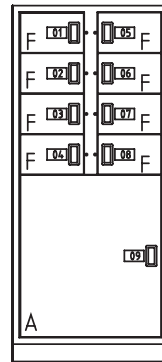

ED3P61

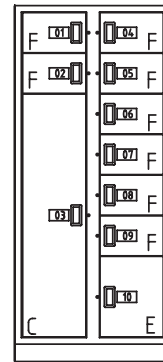

ED3P62

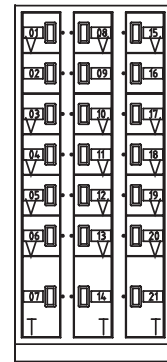

ED3P63

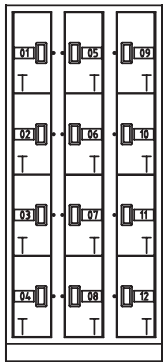

ED3P64

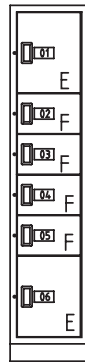

ED3P65

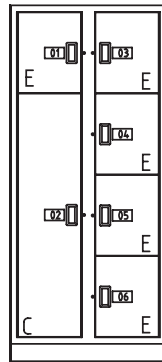

ED3P66

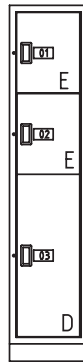

ED3P67

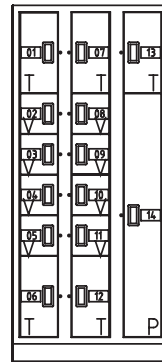

ED3P68

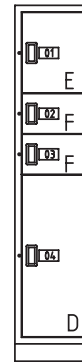

ED3P69

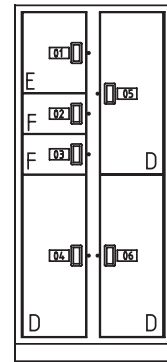

ED3P70

REFRIGERATOR MODEL RS24

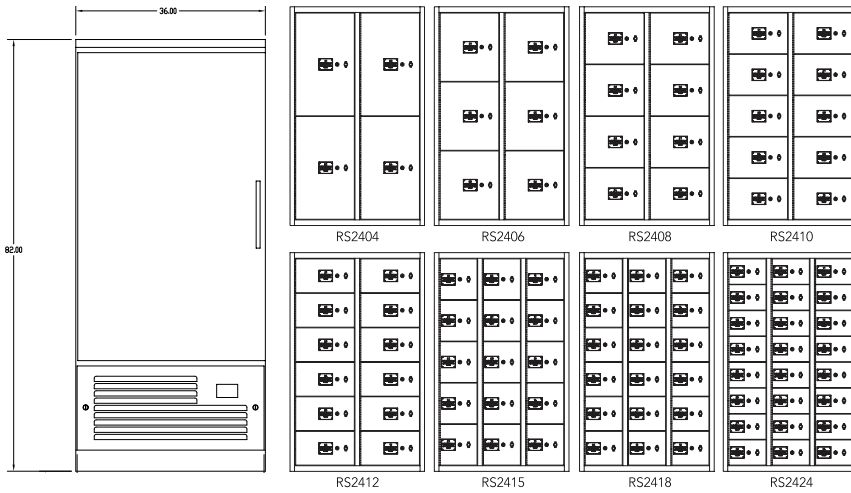

Front View

Interior Compartment Door Configurations

MODEL #	OPENING HEIGHT	WIDTH
EDRS2404PT	22-3/8"	11-3/4"
EDRS2406PT	14-7/8"	11-3/4"
EDRS2408PT	11-1/8"	11-3/4"
EDRS2410PT	8-7/8"	11-3/4"
EDRS2412PT	7-3/8"	11-3/4"
EDRS2415PT	8-7/8"	6-7/8"
EDRS2418PT	7-3/8"	6-7/8"
EDRS2424PT	5-1/2"	6-7/8"

- Depth: All compartments = 17-1/4"
- All dimensions shown indicate maximum size of evidence container that can be put into compartment.
- For non-pass-thru model number, replace PT with NPT

SMALL REFRIGERATOR MODEL RSD4

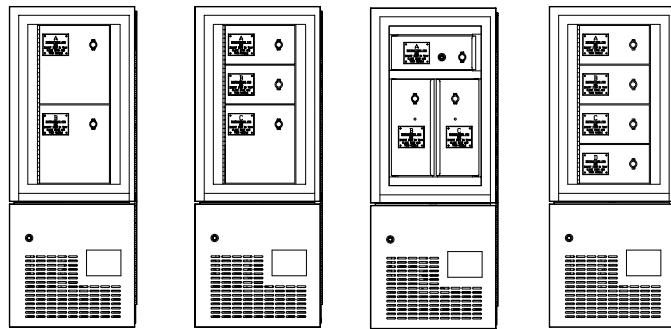

RSD4-2

RSD4-3

RSD4-3V

RSD4-4

Front Views (shown without main door)

MODEL #	OPENING #	INSERT WIDTH	INSERT DEPTH	INSERT HEIGHT
RSD4-2	1 & 2	8.55"	16.13"	8.13"
RSD4-3	1 & 2	8.55"	16.13"	4.06"
	3	8.55"	16.13"	8.13"
RSD4-3V	1	8.55"	16.13"	4.06"
	2 & 3	3.89"	16.13"	12.25"
RSD4-4	1, 2, 3 & 4	8.55"	16.13"	4"

AVAILABLE OPTIONS



Front Lock-out System

When the rear door is opened access is denied to the front doors, further securing your evidence and property room.

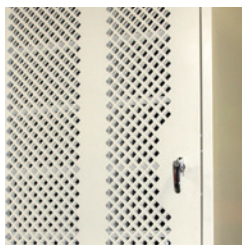

Rear Mesh Doors

Allow visible accounting of evidence. All door components are securely concealed within the double-walled construction.



Mail slots

Provides quick deposit of video tapes, CDs and other small packages. Enhances usable space.



Smart. Storage. Solutions.

www.BRADFORDSYSTEMS.com

Bradford Systems
Corporate Offices
430 Country Club Drive
Bensenville, Illinois 60106
1-800-696-3453

Spacesaver Corporation is a division of KI.

KI is a registered trademark of Krueger International, Inc.

Spacesaver is a registered trademark of Spacesaver Corporation.

© 2015 KI and Spacesaver Corporation. All Rights Reserved. Litho in USA. SSC/MRK Evidence_1215_Broch_PS (SC-0808)